



**CORDLESS
RECIPROCATING SAW
MODEL: 600123625
(MASSB20V)
USER GUIDE**



CAUTION: Read this manual before using this machine!

CONTENTS

1... INTENDED USE.....	3
2... SAFETY INSTRUCTIONS.....	3
3... YOUR PRODUCT.....	6
4... OPERATION.....	7
5... CLEANING AND MAINTENANCE.....	10
6... DISPOSAL.....	10
7... DECLARATION OF CONFORMITY.....	11
8... WARRANTY.....	12
9... PRODUCT FAILURE.....	13
10.WARRANTY EXCLUSIONS.....	14

1. INTENDED USE

This saw intended to be used for cutting wood with the provided blade; that includes plywood, panelling, composition board and hardwood.

Use this blade only for cutting wood. Cutting others material can create accidents and injuries.

Others type of blades can be used in this machine, such as blades for cutting drywall, plastics, metals, etc.

You can purchase them in specialized stores. Use only accessories of same trademark and recommended.

Ask advice to your retailer.

Do not use this tool for others purposes.

2. WARNING INSTRUCTIONS

2.1 GENERAL POWER TOOL SAFETY INFORMATION



WARNING Read all safety warnings, instructions, illustrations and specifications provided with this power tool. *Failure to follow all instructions listed below may result in electric shock, fire and/or serious injury. Save all warnings and instructions for future reference.*

The term "power tool" in the warnings refers to your mains-operated (corded) power tool or battery-operated (cordless) power tool.

1) Work area safety

- a) **Keep work area clean and well lit.** *Cluttered or dark areas invite accidents.*
- b) **Do not operate power tools in explosive atmospheres, such as in the presence of flammable liquids, gases or dust.** *Power tools create sparks which may ignite the dust or fumes.*
- c) **Keep children and bystanders away while operating a power tool.** *Distractions can cause you to lose control.*

2) Electrical safety

- a) **Power tool plugs must match the outlet. Never modify the plug in any way. Do not use any adapter plugs with earthed (grounded) power tools.** *Unmodified plugs and matching outlets will reduce risk of electric shock.*
- b) **Avoid body contact with earthed or grounded surfaces, such as pipes, radiators, ranges and refrigerators.** *There is an increased risk of electric shock if your body is earthed or grounded.*
- c) **Do not expose power tools to rain or wet conditions.** *Water entering a power tool will increase the risk of electric shock.*
- d) **Do not abuse the cord. Never use the cord for carrying, pulling or unplugging the power tool. Keep cord away from heat, oil, sharp edges or moving parts.** *Damaged or entangled cords increase the risk of electric shock.*
- e) **When operating a power tool outdoors, use an extension cord suitable for outdoor use.** *Use of a cord suitable for outdoor use reduces the risk of electric shock.*
- f) **If operating a power tool in a damp location is unavoidable, use a residual current device (RCD) protected supply.** *Use of an RCD reduces the risk of electric shock.*

3) Personal safety

- a) **Stay alert, watch what you are doing and use common sense when operating a power tool. Do not use a power tool while you are tired or under the influence of drugs, alcohol or medication.** *A moment of inattention while operating power tools may result in serious personal injury.*
- b) **Use personal protective equipment. Always wear eye protection.** *Protective equipment such as a dust mask, non-skid safety shoes, hard hat or hearing protection used for appropriate conditions will reduce personal injuries.*
- c) **Prevent unintentional starting. Ensure the switch is in the off-position before connecting to power source and/or battery pack, picking up or carrying the tool.** *Carrying power tools with your*

finger on the switch or energising power tools that have the switch on invites accidents.

- d) **Remove any adjusting key or wrench before turning the power tool on.** *A wrench or a key left attached to a rotating part of the power tool may result in personal injury.*
 - e) **Do not overreach. Keep proper footing and balance at all times.** *This enables better control of the power tool in unexpected situations.*
 - f) **Dress properly. Do not wear loose clothing or jewellery. Keep your hair and clothing away from moving parts.** *Loose clothes, jewellery or long hair can be caught in moving parts.*
 - g) **If devices are provided for the connection of dust extraction and collection facilities, ensure these are connected and properly used.** *Use of dust collection can reduce dust-related hazards.*
 - h) **Do not let familiarity gained from frequent use of tools allow you to become complacent and ignore tool safety principles.** *A careless action can cause severe injury within a fraction of a second.*
- 4) Power tool use and care**
- a) **Do not force the power tool. Use the correct power tool for your application.** *The correct power tool will do the job better and safer at the rate for which it was designed.*
 - b) **Do not use the power tool if the switch does not turn it on and off.** *Any power tool that cannot be controlled with the switch is dangerous and must be repaired.*
 - c) **Disconnect the plug from the power source and/or remove the battery pack, if detachable, from the power tool before making any adjustments, changing accessories, or storing power tools.** *Such preventive safety measures reduce the risk of starting the power tool accidentally.*
 - d) **Store idle power tools out of the reach of children and do not allow persons unfamiliar with the power tool or these instructions to operate the power tool.** *Power tools are dangerous in the hands of untrained users.*
 - e) **Maintain power tools and accessories. Check for misalignment or binding of moving parts, breakage of parts and any other condition that may affect the power tool's operation. If damaged, have the power tool repaired before use.** *Many accidents are caused by poorly maintained power tools.*
 - f) **Keep cutting tools sharp and clean.** *Properly maintained cutting tools with sharp cutting edges are less likely to bind and are easier to control.*
 - g) **Use the power tool, accessories and tool bits etc. in accordance with these instructions, taking into account the working conditions and the work to be performed.** *Use of the power tool for operations different from those intended could result in a hazardous situation.*
 - h) **Keep handles and grasping surfaces dry, clean and free from oil and grease.** *Slippery handles and grasping surfaces do not allow for safe handling and control of the tool in unexpected situations.*
- 5) Battery tool use and care**
- a) **Recharge only with the charger specified by the manufacturer.** *A charger that is suitable for one type of battery pack may create a risk of fire when used with another battery pack.*
 - b) **Use power tools only with specifically designated battery packs.** *Use of any other battery packs may create a risk of injury and fire.*
 - c) **When battery pack is not in use, keep it away from other metal objects, like paper clips, coins, keys, nails, screws or other small metal objects, that can make a connection from one terminal to another.** *Shorting the battery terminals together may cause burns or a fire.*
 - d) **Under abusive conditions, liquid may be ejected from the battery; avoid contact. If contact accidentally occurs, flush with water. If liquid contacts eyes, additionally seek medical help.** *Liquid ejected from the battery may cause irritation or burns.*
 - e) **Do not use a battery pack or tool that is damaged or modified.** *Damaged or modified batteries may exhibit unpredictable behaviour resulting in fire, explosion or risk of injury.*
 - f) **Do not expose a battery pack or tool to fire or excessive temperature.** *Exposure to fire or temperature above 130 °C may cause explosion. NOTE The temperature „130 °C“ can be replaced by the temperature „265 °F“.*

g) Follow all charging instructions and do not charge the battery pack or tool outside the temperature range specified in the instructions. Charging improperly or at temperatures outside the specified range may damage the battery and increase the risk of fire.

6) Service

a) Have your power tool serviced by a qualified repair person using only identical replacement parts. This will ensure that the safety of the power tool is maintained.

b) Never service damaged battery packs. Service of battery packs should only be performed by the manufacturer or authorized service providers.

2.2 SAFETY INSTRUCTIONS FOR RECIPROCATING SAWS

a) c) Hold the power tool by insulated gripping surfaces, when performing an operation where the cutting accessory may contact hidden wiring. Cutting accessory contacting a "live" wire may make exposed metal parts of the power tool "live" and could give the operator an electric shock.

b) d) Use clamps or another practical way to secure and support the workpiece to a stable platform. Holding the workpiece by hand or against your body leaves it unstable and may lead to loss of control.

2.3 SPECIFIC SAFETY RULES







- Do not stare at the tool with the blade touching any surface. The blade action will bounce the tool and may cause bodily injury.
- Allow the tool to come to a complete stop before putting it down. A running tool will jerk when the blade tip contacts any surface.
- Always wear safety glasses or goggles, normal prescription eye or sunglasses are not safety glasses.
- Do not cut oversized work pieces.
- Do not cut nails or screws unless you are using a blade specifically designed for this purpose. Inspect your material before cutting.
- Before switching on the tool, be sure that the blade is not contacting the work piece.
- Keep hands away from moving parts and on the top surface of the work piece. Do not place hands below work surface while saw is operating.
- Check your area for proper clearance before cutting. This will avoid cutting into your workbench, the floor, etc.

2.4 RESIDUAL RISKS

Even with use of the tool as described, it is impossible to eliminate all residual risk factors. The following hazards may be present in connection with the construction and design of the tool:

- Pulmonary lesions if an effective mask is not worn.
- Hearing damage if effective hearing protection is not worn.
- Body injuries caused by vibration emissions if the electrical appliance is used improperly or for a prolonged or poorly maintained period.

2.5 EXPLANATION OF SYMBOLS

	Conforms to relevant safety standards.		Wear eye protection.
	To reduce the risk of injury, the user must read and understand this manual before using this product.		Wear respiratory protection.
	Wear ear protectors. Exposure to noise can cause hearing loss.		Do not dispose of old appliances with domestic rubbish.

3. YOUR PRODUCT

3.1 DESCRIPTION

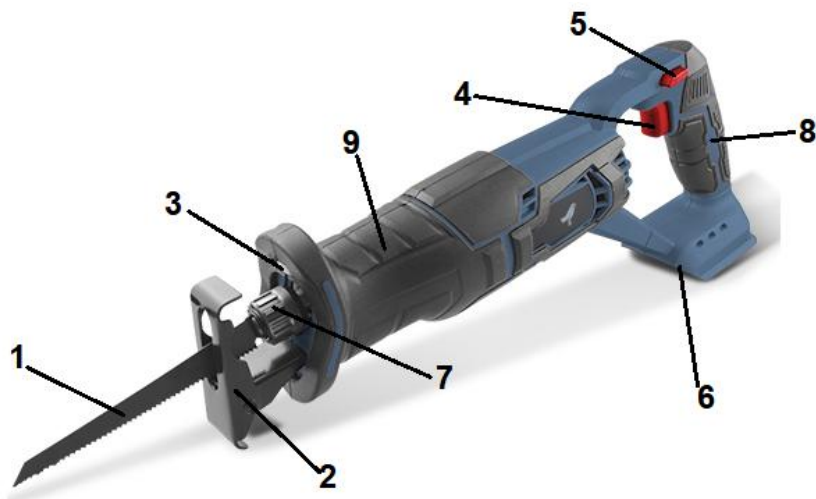

- 1) Saw blade
- 2) Soleplate
- 3) Led light
- 4) ON/OFF switch
- 5) Lock-off button for ON/OFF switch
- 6) Battery platform
- 7) Blade clamp and release mechanism
- 8) Handle
- 9) Grasping surface

3.2 TECHNICAL DATA

Tension	20V d.c.
No load speed	0-2800/min
Blade stroke	22mm
Cutting capacity	65mm in wood / 6 mm in metal
Battery pack (not included)	ENERGY PACK 600105097 (MABC20V2A) 20V d.c. 2Ah Lithium-ion
Charger (not included)	ENERGY PACK 600105097 (MABC20V2A) Input 220-240V~ 50-60Hz, 65W Output; 21V d.c. 2.5A
Sound power level	L _{WA} : 92.93dB(A) K=5dB(A)
Sound pressure level	L _{pA} : 81.93dB(A) K=5dB(A)
Vibration	Cutting board mode: - Front handle: 14 m/s ² - Rear handle: 12,3 m/s ² Cutting wooden beams mode - Front handle: 10,5 m/s ² - Rear handle: 16,8 m/s ² K= 1,5m/s ²

Information:

- The declared vibration total value(s) and the declared noise emission value(s) have been measured in accordance with a standard test method and may be used for comparing one tool with another;
- The declared vibration total value(s) and the declared noise emission value(s) may also be used in a preliminary assessment of exposure.

Warning:

- The vibration and noise emissions during actual use of the power tool can differ from the declared values depending on the ways in which the tool is used especially what kind of workpiece is processed;
- Of the need to identify safety measures to protect the operator that are based on an estimation of exposure in the actual conditions of use (taking account of all parts of the operating cycle such as the times when the tool is switched off and when it is running idle in addition to the trigger time).
- Wear hearing protection.

4. OPERATION

4.1 CHARGING THE BATTERY PACK

Battery and charger not included, you can buy the energy pack 600105097 (MABC 20V 2A) from Auchan.

IMPORTANT: The battery pack is not fully charged at the factory.

Before attempting to charge them, thoroughly read all of the safety instructions.

Charge only at ambient temperatures between 4°C and 40°C (39.2°F and 104°F)

Store your batteries in a cool dry place (5°C-20°C/41°F-68°F). Do not store in locations where the temperature may exceed 40°C (104°F). Never store batteries in discharged state.

The recommended ambient temperature range for battery use is from -5°C to 50 °C.

- 1) Assure that the charger you are using matches your battery pack.
- 2) Insert the charger into 220-240V~, 50-60Hz outlet. The indicator light will turn to red to show the power is connected.
- 3) Insert the battery into the slot of charger . Make sure the contact with the charger is correct.
- 4) The indicator light becomes green and will flash when charging.
- 5) When fully charged the indicator light becomes to green.
- 6) Frequently monitor the charger and battery pack while connected.
- 7) Unplug the charger and disconnect it from the battery pack when finished.
- 8) Allow the battery pack to cool completely before using it.
- 9) Store the charger and battery pack indoors, out of reach of children.



Note: If the battery does not fit properly, disconnect it and confirm that the battery pack is the correct model for this charger as shown on the specification chart. Do not charge any other battery pack or any battery pack that does not securely fit the charger.



NOTE: If battery is hot after continuous use in the tool, allow it to cool down to room temperature before charging. This will extend the life of your batteries.



NOTE: Remove battery pack from charger stand which use your thumb or fingers, press the battery's release button in and pull the battery pack off at the same time.

Battery capacity indicator

There are battery capacity indicators on the battery pack; you can check the capacity status of the battery if you squeeze the button . Before using the machine, please press switch trigger to check if the battery is full enough for properly working.

Those 3 LED might show the status of the capacity level of the battery: Inserting and removing the battery.



WARNING: Before making any adjustments ensure the drill is switched off with the direction of rotation selector in the center position

- 1) Remove the battery: press the battery release latch in and at the same time pull the battery pack off.
- 2) To insert the battery: position it on the base, then slide while pressing until the end of the battery pack of the tool.

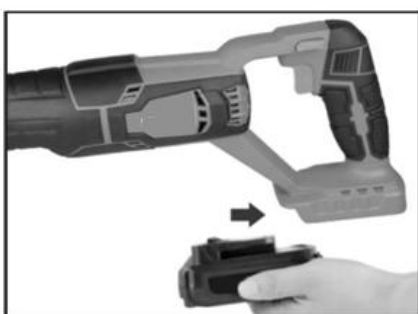

FIG.1

Warning! Always remove the battery from the tool when assembling accessories, making adjustments, during transport or when the tool is not in use. Remove the battery will prevent accidental starting which could cause severe personal injury.

NOTE: To avoid serious personal injury, always remove the battery and keep your hands away from the lock button while transporting the tool.

4.2 INSTALL / REMOVE THE SAW BLADE

The product is provided with a blade, intended to be used for cutting wood. That includes plywood, panelling, composition board and hardwood.

Use this blade only for cutting wood. Cutting others material can create accidents and injuries.

Others type of blades can be used in this machine, such as blades for cutting drywall, plastics, metals, etc. You can purchase them in specialized stores. Use only accessories of same trademark and recommended. Ask advice to your retailer.

- Turn the quick-release blade clamp (6) anticlockwise and insert the saw blade, then release the quick-release blade clamp(6). Make sure that the saw blade is securely fastened. (Fig. 2)
- Turn the quick-release blade clamp (6) anticlockwise to remove the saw blade.(Fig. 3)



Fig. 2

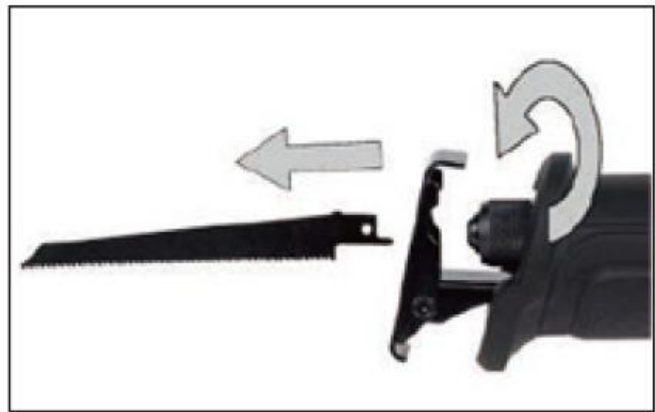

Fig. 3

NOTE: The blade must be inserted with the teeth tuned downwards, the side with the hole must be inserted in the spindle. Failure to install the blade will cause damage, accidents and injuries.

4.3 SOLEPLATE ASSEMBLY ADJUSTMENT

- Loosen the two cap screws at the bottom of the front handle with the hex key provided.(Fig. 4)
- Move the pivot shoe (2) in or out to the position required.
- Tighten both cap screws.



Fig. 4

4.4 STARTING AND STOPPING

- a) The reciprocating saw is equipped with a lock button (3) which reduces the possibility of accidental starting. The lock button (3) is located on the handle above the on/off switch trigger. You must depress the lock button in order to pull the switch trigger. The lock button resets each time the trigger is released.
- b) To turn on the reciprocating saw, depress the lock button (3) and pull the ON/OFF switch trigger (4).
- c) Release the ON/OFF switch trigger to turn off the reciprocating saw.
- d) The speed of the reciprocating saw can be increased by increasing the pressure on the ON/OFF switch trigger. Decrease the pressure on the ON/OFF switch trigger will decrease the speed of the reciprocating saw.

4.5 GENERAL CUTTING

Hold the saw firmly in front and clearly away from you.

Make sure that the blade is clear of any foreign material.

Be sure material to be cut is held firmly.

Small workpiece should be securely clamped in vice or with clamps to the workbench or table.

Mark the line of cut clearly.

Depress the lock off button then pull the ON/OFF switch to start the cutting action.

Place the base assembly against the workpiece, then move the blade into it.

Do not force. Use only enough pressure to keep the saw cutting.

Let the blade do the work.

The use of excessive pressure that causes bending or twisting of the blade and may break it.

4.6 PLUNGE CUTTING

Mark the line of cut clearly.

Choose a convenient starting point inside the area to be cut out and place the tip of the blade over that point.

Rest the front edge of shoe assembly on the workpiece and hold firmly in position.

Depress the lock off button then pull the ON/OFF trigger to start the cutting.

Make sure that blade does not touch work until motor reaches full speed, since this could cause loss of control resulting in serious injury.

With blade at full cutting speed, slowly tilt saw downward until the blade starts cutting.

After blade penetrates the workpiece, tilt saw until blade is perpendicular to the workpiece.

WARNING:

Blade longer than 15cm can whip and should not be used for plunge cutting. Failure to heed this warning can result in serious personal injury.

Cutting into electrical wiring can cause the blade, blade clamp and the saw assembly to become electrically live. Do not touch metal part parts when cutting into a wall. Grasp only the insulated surfaces on the tool. make sure the hidden electrical wiring, water pipes, and mechanical hazards are not in the blade path when cutting into a wall.

4.7 METAL CUTTING

You may cut metal such as sheet steel, pipe, steel rod, aluminium, brass and copper with this tool by using the appropriate cutting blade (do not use the provided blade but buy a blade for metal cutting matching with this tool).

When metal cutting:

- Do not twist or bend the blade
- Do not force the tool and use a slow speed setting
- Use a cutting oil when cutting soft metal and steel. Cutting oil also keeps the blade cool, increases cutting action and prolongs blade life.
- Never use gasoline since normal sparking of motor could ignite fumes.
- Clamp the workpiece firmly and cut close to the clamping point to eliminate any vibration of the workpiece. When cutting conduit pipe or angle iron, clamp the workpiece in a vice if possible and cut close to the vice. To cut thin sheet material, "sandwich" the material between hardboard or plywood and clamp the layers to eliminate vibration and material tearing.

5. MAINTENANCE AND STORAGE

a. Maintenance

- After use and before cleaning and maintenance, remove the blade and the battery from the tool.
- Clean the housing only with a damp cloth. Do not use solvents! Then wipe thoroughly.
- Check the condition of the tool. If the tool is damaged or has malfunction, do not use it and bring it to a qualified service for inspection or repair.
- To maintain the optimum battery power, we recommend that the battery be discharged and recharged every two months.

b. Storage

Remove the battery from the tool.

Store the tool in a dry place and protected from freezing, the ambient temperature should not exceed 50°C. Put it out of the reach of children.

6. DISPOSAL



Electrical products should not be discarded with household products. According to the European Directive 2012/19/UE on waste electrical and electronic equipment and its implementation into national law, electrical products used must be collected separately and disposed of at collection points provided for this purpose. Talk with your local authorities or dealer for advice on recycling.

EC / UE Declaration of Conformity / Déclaration de conformité CE / EU

**"EO" ДЕКЛАРАЦИЯ ЗА СЪОТВЕТСТВИЕ / DECLARACIÓN "CE" DE CONFORMIDAD
EK-MEGFELELŐSÉGI NYILATKOZAT / DICHIARAZIONE "CE" DI CONFORMITÀ
DEKLARACJA ZGODNOŚCI WE / DECLARAÇÃO "CE" DE CONFORMIDADE
DECLARAȚIA „CE” DE CONFORMITATE**

We, manufacturer / Nous, fabricant

Мы - производители / Nosotros, fabricantes
Mi, a gyártók / Noi, i produttori / Мы, producenci
Nós, os fabricantes / Noi, producătorii

AUCHAN SAS OIA
200 rue de la recherche
59650 Villeneuve d'Ascq
FRANCE

Declare under sole responsibility that the product / déclarons sous notre seule responsabilité que le produit
декларируем под нашу личную ответственность, что продукт / declaramos bajo nuestra única responsabilidad que el producto
kijelentjük saját felelősségünkre, hogy a termék / dichiara sotto la propria responsabilità che il prodotto / deklaruje z pełną odpowiedzialnością, że wyrób
declaramos sob nossa única responsabilidade que o produto / declarăm pe propria răspundere că produsul



Ref / Code : 600123625
Ref fournisseur / Supplier ref : 3665257351540
Description : CORDLESS SABER SAW

Is in compliance to the following regulations / est conforme à la législation communautaire d'harmonisation applicable
Соответствует следующим правилам / Cumples con las siguientes regulaciones / Megfelel az alábbi előírásoknak / E conforme ai seguenti regolamenti
Jest zgodny z następującymi przepisami / Está em conformidade com os seguintes regulamentos / Respectă următoarele reglementări

2014/30/UE (EMC) Directive
2011/65/UE+(EU)2015/863 (ROHS)
Directive 2006/42/CE (MACHINE)

Relevant harmonised standards used / Normes harmonisées appliquées / Соответствующие согласованные стандарты / Normas armonizadas
pertinentes utilizadas / A vonatkozó harmonizált szabványok / Norme armonizzate pertinenti utilizzate
Stosowane normy zharmonizowane / Normas armonizadas relevantes utilizadas / Standardele armonizate relevante utilizate

EN 55014-1: 2017 + A11: 2020
EN 55014-2 : 2015
EN 62841-1:2015
EN 62841-2-11:2016/A1:2020

Signed for and on behalf to :

Cédric WILLAY
Quality Manager
Villeneuve d'Ascq, France
09/01/2022



8. WARRANTY

The manufacturer guarantees the product against defects in material and workmanship for a period of 2 years from the date of the original purchase. The warranty only applies if the product is for household use. The warranty does not cover breakdowns due to normal wear and tear.

The manufacturer agrees to replace parts identified as defective by the designated distributor. The manufacturer does not accept responsibility for the replacement of the machine, in whole or in part, and/or ensuing damage.

The warranty does not cover breakdowns due to:

- insufficient maintenance.
- abnormal assembly, adjustment or operations of the product.
- parts subject to normal wear and tear.

The warranty does not extend to:

- shipping and packaging costs.
- using the tool for a purpose other than that for which it was designed.
- the use and maintenance of the machine done in a manner not described in the user manual.

Due to our policy of continuous product improvement, we reserve the right to alter or change specifications without notice. Consequently, the product may be different from the information contained therein, but a modification will be undertaken without notice if it is recognized as an improvement of the preceding characteristic.

READ THE MANUAL CAREFULLY BEFORE USING THE MACHINE.

When ordering spare parts, please indicate the part number or code, you can find this in the spare parts list in this manual. Keep the purchase receipt; without it, the warranty is invalid. To help you with your product, we invite you to contact us by phone or via our website:

- **+33 (0)9.70.75.30.30**
- **<https://services.swap-europe.com/contact>**

You must create a "ticket" via the web platform.

- Register or create your account.
- Indicate the reference of the tool.
- Choose the subject of your request.
- Describe your problem.
- Attach these files: invoice or sales receipt, photo of the identification plate (serial number), photo of the part you need (for example: pins on the transformer plug which are broken).



9. PRODUCT FAILURE

WHAT TO DO IF MY MACHINE BREAKS DOWN?

If you bought your product in a store:

- Make sure that your machine is complete with all accessories supplied, and clean! If this is not the case, the repairer will refuse the machine.
- Go to the store with the complete machine and with the receipt or invoice.

If you bought your product on a website:

- Make sure that your machine is complete with all accessories supplied, and clean! If this is not the case, the repairer will refuse the machine.
- Create a SWAP-Europe service ticket on the site: <https://services.swap-europe.com> When making the request on SWAP-Europe, you must attach the invoice and the photo of the nameplate (serial number). Contact the repair station to make sure it is available before dropping off the machine.

Go to the repair station with the complete machine packed, accompanied by the purchase invoice and the station support sheet downloadable after the service request is completed on the SWAP-Europe site

Please keep your original packaging to allow for after-sales service returns or pack your machine with a similar cardboard box of the same dimensions.

For any question concerning our after-sales service you can make a request on our website <https://services.swap-europe.com>

Our hotline remains available at +33 (9) 70 75 30 30.



10.WARRANTY EXCLUSIONS

THE WARRANTY DOES NOT COVER:

- Start-up and setting up of the product.
- Damage resulting from normal wear and tear of the product.
- Damage resulting from improper use of the product.
- Damage resulting from assembly or start-up not in accordance with the user manual.
- Breakdowns related to carburetion beyond 90 days and fouling of carburetors.
- Periodic and standard maintenance events.
- Actions of modification and dismantling that directly void the warranty.
- Products whose original authentication marking (brand, serial number) has been degraded, altered or withdrawn.
- Replacement of consumables.
- The use of non-original parts.
- Breakage of parts following impacts or projections.
- Accessories breakdowns.
- Defects and their consequences linked to any external cause.
- Loss of components and loss due to insufficient screwing.
- Cutting components and any damage related to the loosening of parts.
- Overload or overheating.
- Poor power supply quality: faulty voltage, voltage error, etc.
- Damages resulting from the deprivation of enjoyment of the product during the time necessary for repairs and more generally the costs related to the immobilization of the product.
- The costs of a second opinion established by a third party following an estimate by a SWAP-Europe repair station
- The use of a product which would show a defect or a breakage which was not the subject of an immediate report and/or repair with the services of SWAP-Europe.
- Deterioration linked to transport and storage*.
- Launchers beyond 90 days.
- Oil, petrol, grease.
- Damages related to the use of non-compliant fuels or lubricants.

* In accordance with transport legislation, damage related to transport must be declared to carriers within 48 hours maximum after observation by registered letter with acknowledgement of receipt.

This document is a supplement to your notice, a non-exhaustive list.

Attention: all orders must be checked in the presence of the delivery person. In case of refusal by the delivery person, it you must simply refuse the delivery and notify your refusal.

Reminder: the reserves do not exclude the notification by registered letter with acknowledgement within 72 hours.

Information:

Thermal devices must be wintered each season (service available on the SWAP-Europe site). Batteries must be charged before being stored.



AUCHAN

www.auchan-retail.com/contact

SAS OIA, 200, rue de la Recherche, Le Colibri

BP 169, 59650 Villeneuve d'Ascq, France

Tel: 00 800 5922 5922

Made in China(09/2022) - Réf. 600123625(MASSB20V)

